







CHAGAS**TABELA DE PREÇOS**

CÓDIGO	DESCRIÇÃO	UN.	PVP	PRODUTO	QUANT. EMBALAGEM
5404001	PF CT AQ DIN 603 4.6 M 5x 25 ZN	MI	19,50 €		500
5404008	PF CT AQ DIN 603 4.6 M 5x 50 ZN&	MI	- €		200
5404012	PF CT AQ DIN 603 4.6 M 6x 20 ZN	MI	27,00 €		300
5404014	PF CT AQ DIN 603 4.6 M 6x 25 ZN	MI	27,90 €		300
5404016	PF CT AQ DIN 603 4.6 M 6x 30 ZN	MI	31,70 €		200
5404018	PF CT AQ DIN 603 4.6 M 6x 35 ZN	MI	37,20 €		200
5404020	PF CT AQ DIN 603 4.6 M 6x 40 ZN	MI	39,00 €		200
5404022	PF CT AQ DIN 603 4.6 M 6x 45 ZN	MI	40,00 €		200
5404024	PF CT AQ DIN 603 4.6 M 6x 50 ZN	MI	41,00 €		200
5404026	PF CT AQ DIN 603 4.6 M 6x 55 ZN	MI	42,00 €		200
5404028	PF CT AQ DIN 603 4.6 M 6x 60 ZN	MI	47,00 €		200
5404032	PF CT AQ DIN 603 4.6 M 6x 70 ZN	MI	55,00 €		200
5404034	PF CT AQ DIN 603 4.6 M 6x 80 ZN	MI	65,60 €		200
5404036	PF CT AQ DIN 603 4.6 M 6x 90 ZN	MI	76,40 €		200
5404038	PF CT AQ DIN 603 4.6 M 6x100 ZN	MI	80,00 €		200
5404060	PF CT AQ DIN 603 4.6 M 8x 20 ZN	MI	52,40 €		200
5404062	PF CT AQ DIN 603 4.6 M 8x 25 ZN	MI	55,00 €		200
5404064	PF CT AQ DIN 603 4.6 M 8x 30 ZN	MI	57,50 €		200
5404066	PF CT AQ DIN 603 4.6 M 8x 35 ZN	MI	59,30 €		200
5404068	PF CT AQ DIN 603 4.6 M 8x 40 ZN	MI	70,80 €		200
5404070	PF CT AQ DIN 603 4.6 M 8x 45 ZN	MI	71,00 €	200	
5404072	PF CT AQ DIN 603 4.6 M 8x 50 ZN	MI	73,10 €	200	
5404074	PF CT AQ DIN 603 4.6 M 8x 55 ZN	MI	75,00 €	200	
5404076	PF CT AQ DIN 603 4.6 M 8x 60 ZN	MI	83,00 €	200	
5404080	PF CT AQ DIN 603 4.6 M 8x 70 ZN	MI	96,40 €	100	
5404084	PF CT AQ DIN 603 4.6 M 8x 80 ZN	MI	110,00 €	100	
5404086	PF CT AQ DIN 603 4.6 M 8x 90 ZN	MI	118,70 €	100	
5404088	PF CT AQ DIN 603 4.6 M 8x100 ZN	MI	151,60 €	100	
5404090	PF CT AQ DIN 603 4.6 M 8x110 ZN	MI	187,50 €	100	
5404092	PF CT AQ DIN 603 4.6 M 8x120 ZN	MI	200,00 €	100	
5404094	PF CT AQ DIN 603 4.6 M 8x130 ZN	MI	220,00 €	100	
5404096	PF CT AQ DIN 603 4.6 M 8x140 ZN	MI	250,70 €	100	
5404098	PF CT AQ DIN 603 4.6 M 8x150 ZN	MI	267,80 €	100	
5404124	PF CT AQ DIN 603 4.6 M10x 30 ZN	MI	96,00 €	100	
5404128	PF CT AQ DIN 603 4.6 M10x 40 ZN	MI	106,30 €	100	
5404132	PF CT AQ DIN 603 4.6 M10x 50 ZN	MI	126,10 €	100	
5404136	PF CT AQ DIN 603 4.6 M10x 60 ZN	MI	140,00 €	100	
5404140	PF CT AQ DIN 603 4.6 M10x 70 ZN	MI	169,70 €	100	
5404144	PF CT AQ DIN 603 4.6 M10x 80 ZN	MI	180,00 €	100	
5404146	PF CT AQ DIN 603 4.6 M10x 90 ZN	MI	219,20 €	100	
5404148	PF CT AQ DIN 603 4.6 M10x100 ZN	MI	240,10 €	100	
5404150	PF CT AQ DIN 603 4.6 M10x110 ZN	MI	288,50 €	50	
5404152	PF CT AQ DIN 603 4.6 M10x120 ZN	MI	311,70 €	50	
5404158	PF CT AQ DIN 603 4.6 M10x150 ZN	MI	381,40 €	50	
5404168	PF CT AQ DIN 603 4.6 M10x200 ZN&	MI	390,00 €	50	
5404236	PF CT AQ DIN 603 4.6 M12x 60 ZN	MI	246,60 €	100	

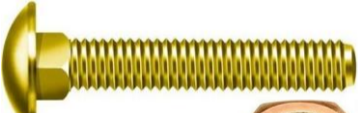
CHAGAS**TABELA DE PREÇOS**

CÓDIGO	DESCRIÇÃO	UN.	PVP	PRODUTO	QUANT. EMBALAGEM
5406012	PARAF TR SX DIN 571 ST H 6x30 ZN	MI	19,70 €		
5406014	PARAF TR SX DIN 571 ST H 6x35 ZN	MI	25,50 €		
5406016	PARAF TR SX DIN 571 ST H 6x40 ZN	MI	26,00 €		
5406018	PARAF TR SX DIN 571 ST H 6x45 ZN	MI	26,30 €		
5406020	PARAF TR SX DIN 571 ST H 6x50 ZN	MI	28,90 €		
5406024	PARAF TR SX DIN 571 ST H 6x60 ZN	MI	31,90 €		
5406026	PARAF TR SX DIN 571 ST H 6x70 ZN	MI	34,50 €		
5406028	PARAF TR SX DIN 571 ST H 6x80 ZN	MI	48,20 €		
5406048	PARAF TR SX DIN 571 ST H 7x60 ZN	MI	49,10 €		
5406050	PARAF TR SX DIN 571 ST H 7x80 ZN	MI	72,00 €		
5406052	PARAF TR SX DIN 571 ST H 7x90 ZN	MI	75,00 €		
5406054	PARAF TR SX DIN 571 ST H 7x100ZN	MI	80,00 €		
5406056	PARAF TR SX DIN 571 ST H 7x110ZN	MI	92,50 €		
5406058	PARAF TR SX DIN 571 ST H 7x120ZN	MI	95,00 €		
5406090	PARAF TR SX DIN 571 ST H 8x50 ZN	MI	55,00 €		
5406094	PARAF TR SX DIN 571 ST H 8x60 ZN	MI	60,00 €		
5406096	PARAF TR SX DIN 571 ST H 8x70 ZN	MI	75,50 €		
5406102	PARAF TR SX DIN 571 ST H 8x80 ZN	MI	80,00 €		
5406104	PARAF TR SX DIN 571 ST H 8x90 ZN	MI	88,30 €		
5406106	PARAF TR SX DIN 571 ST H 8x100ZN	MI	97,00 €		
5406110	PARAF TR SX DIN 571 ST H 8x120ZN	MI	111,80 €		
5406114	PARAF TR SX DIN 571 ST H 8x140ZN	MI	137,40 €		
5406132	PARAF TR SX DIN 571 ST H10x40 ZN&	MI	81,00 €		
5409010	PARAF.CO COMPL.1/4"x15 PASS.AMAR.	MI	73,50 €		100
5409015	PARAF.CO COMPL.1/4"x25 PASS.AMAR.	MI	54,20 €		100
5409050	PARAF.C/OVAL 1/4"x15 PASS.AMAR.	MI	42,40 €		500
5409055	PARAF.C/OVAL 1/4"x25 PASS.AMAR.	MI	23,00 €		500
5409060	ANILHA CHAPA 1/4" PASS.AMAR.	MI	5,50 €		1000
5409070	PORCA SEXTAV. 1/4" PASS.AMAR.	MI	25,80 €		1000

CHAGAS**TABELA DE PREÇOS**

CÓDIGO	DESCRIÇÃO	UN.	PVP	PRODUTO	QUANT. EMBALAGEM
--------	-----------	-----	-----	---------	---------------------

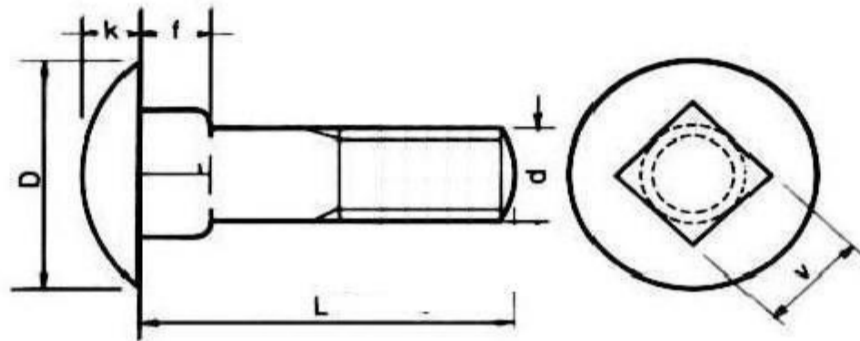
DIN 603**PARAF. CAB. OVAL C/ARREIGADA QUAD.**

d mm	M5	M6	M8	M10	M12	M16
D	13	16	20	24	30	38
k	3	3,5	4,5	5	6,5	8,5
f	3,5	4	5	6	8	12
v	5	6	8	10	12	16
m	4	5	6,5	8	10	13
b	com rosca na totalidade					
	x					
	y	16	18	22	26	30
z	22	24	28	32	36	44

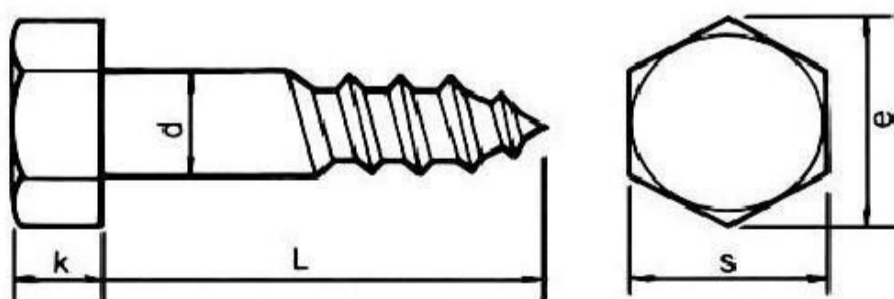
TIREFOND PARA MADEIRA CABEÇA SEXTAVADA**DIN 571**

d mm	4	5	6	8	10	12
S	7	8	10	13	17	19
e	7,5	8,63	10,89	14,20	18,72	20,88
k	2,8	3,5	4	5,5	7	8